



K300 Spares & Accessories Catalogue

K300

Domino. Do more.

Contents

Introduction	2
Consumable Kits & Consumables	3
Consumable Kits.....	3
Consumables	3
Mechanical Accessories	4
Stand.....	5
Stand Adapters.....	6
Print Station Mounting.....	9
Electrical Accessories	10
Beacon.....	11
Mains Cables.....	12
Sensors & Encoders	18
Sensors.....	19
Encoders.....	21
K300 Spares	24
Base Station Spares	25
Print Station Spares.....	29
Conduits	33
Generic Spares.....	34
Controller	36
DCI Type2	39
Domino Cloud Interface.....	39
Documentation	41
Notes	42

Introduction

This document provides useful information about the current K300 spares and accessories including photography, part numbers and descriptions.

For all Pin outs & wiring diagrams, please refer to the Product Manual on MyDomino.



Note: This is a working document and will be continuously updated; the newest version of this document will always be available from MyDomino.

Consumable Kits & Consumables

Consumable Kits

Image	Description	Quantity per kit
	<p>EPT091044 K300 Starter Kit</p> <p>Kit Components: Wipes Gloves Safety Glasses Wash Bottle Ink Tray</p>	1

Consumables

Image	Description	Quantity per kit
	<p>EPT069192 K300 Print Head Wipes, Pack of 100</p>	1
	<p>EPT095454 K300 Nozzle Wiper, pack of 5</p>	1

Mechanical Accessories

- Stand..... 5**
 - Printer Stand Type 2 - EPT036922.....5
- Stand Adapters..... 6**
 - Cupboard Assembly - EPT021994.....6
 - Stacking Kit - EPT0117607
 - Wash Station Assembly -EPT096585.....8
- Print Station Mounting..... 9**
 - K300 Adjustable Mount Assembly - EPT078404.....9

Stand

Product	Technical Data
<p>Printer Stand Type 2 - EPT036922</p> <p>Description: This stand enables a complete mobile coding station to be created around the K300 supporting a broad range of configurations.</p>	<ul style="list-style-type: none"> • Height adjustable feet • Stainless steel - 316 Grade

Image/ Diagram



Connection/ Fitting





Stand Adapters

Product	Kit Components
<p>Cupboard Assembly - EPT021994</p> <p>Description: This cabinet provides storage and can be bolted to the Stand Assembly.</p> <p>Note: For Use with the Stand Assemblies.</p>	<p>1 x Panel Assembly Lock Side 1 x Rear Cupboard Panel 1 x Panel Assembly 2 x Gusset Cupboard Assembly 16 x Screw Hex St St M3 x 8mm 1 x Cupboard Front Door Assembly 1 x Shelf</p>

Image/ Diagram



Product	Technical Data	
<p>Stacking Kit - EPT011760</p> <p>Description: This kit is used to either mount a K300 printer to the floor or stack them to a maximum of 3 printers high.</p>	<ul style="list-style-type: none"> • Stainless Steel Sheet • Expanding Floor Anchor Bolt M6 x 70mm 	
Image/ Diagram		
		
Connection/ Fitting	Kit Components	
	<p>4 x Plate Mounting 3 High Unit Stack 2 x Bracket Stand Mounting Assembly 4 x Expanding Floor Anchor Bolt M6 x 70mm</p>	

Product	Technical Data
<p>Wash Station Assembly - EPT096585</p> <p>Description: Used primarily for washing K300 wipe tool and sealing cap. Designed to be mounted onto the side of the K300 Base unit, it comes with jug for collecting waste fluid</p>	<ul style="list-style-type: none"> • Stainless Steel Sheet • Collection pot
Image/ Diagram	
	
Kit Components	
<ul style="list-style-type: none"> 1 x Wash Station Tank Assy 2 x Supporting Rod 1 x Jug Base Assy 4 x Screw M3x5 1 x Base Bracket 5 x Screw M6x6 1 x Wash Station Jug 	

Print Station Mounting

Product	Kit Components
<p>K300 Adjustable Mount Assembly - EPT078404</p> <p>Description: Used to mount the Print Station. One print station can be used per mount assembly.</p>	<p>1 x K300 Rail Assembly 1 x K300 Mount and Carriage Assembly</p>

Image/ Diagram

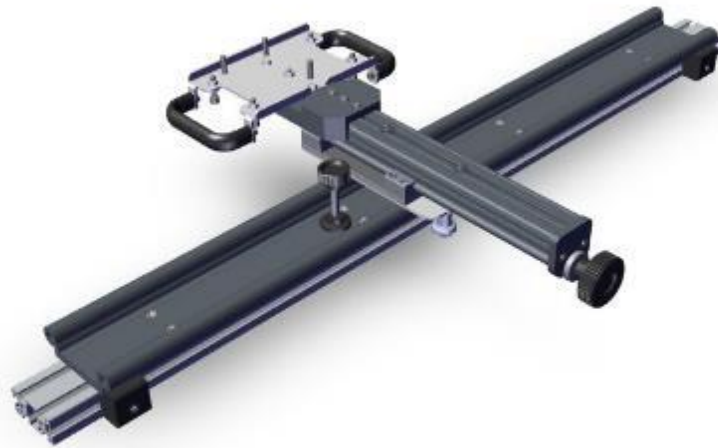

Connection/ Fitting



Electrical Accessories

- Beacon**..... 11
 - K300 Beacon Assembly Kit - EPT083421 11
- Mains Cables**..... 12
 - Mains Cable 2.0m IEC Euro - EPT060866 12
 - Mains Cable 2.0m IEC UK - EPT060865 13
 - Mains Cable 2.0m IEC US - EPT026724 14
 - Mains Cable 2.0m IEC China - EPT026722..... 15
 - Mains Cable 2.0m IEC Aus/Nz - EPT053520..... 16
 - Mains Cable 2.0m IEC No Plug - 78055 17

Beacon

Product	Kit Components
<p>K300 Beacon Assembly Kit - EPT083421</p> <p>Description: The beacon displays the status of the printer using a colour LED System. Up to two mounted per Base Unit, one per print station assembled.</p>	<p>1 x K300 Beacon Assembly 1 x K300 Beacon Bracket 2 x Screw Socket Button Head M6 x 12 A4</p>

Image/ Diagram



Connection/ Fitting



Mains Cables

Product	Technical Data
<p>Mains Cable 2.0m IEC Euro - EPT060866</p> <p>Description: European power lead for the K300 Base Station.</p>	<ul style="list-style-type: none">• 2m Cable

Image / Diagram



Product	Technical Data
<p data-bbox="204 293 687 371">Mains Cable 2.0m IEC UK - EPT060865</p> <p data-bbox="204 416 775 483">Description: UK power lead for the K300 Base Station.</p>	<ul data-bbox="874 264 1050 297" style="list-style-type: none">• 2m Cable
Image / Diagram	
 A black 2.0m IEC UK mains cable is shown. The cable is coiled and features a standard three-pronged UK plug with gold-colored contacts. The other end of the cable has a black, rectangular connector with a locking mechanism, typical for industrial or base station equipment.	

Product	Technical Data
<p>Mains Cable 2.0m IEC US - EPT026724</p> <p>Description: US power lead for the K300 Base Station</p>	<ul style="list-style-type: none">• 2m Cable

Image / Diagram



Product	Technical Data
<p>Mains Cable 2.0m IEC China - EPT026722</p> <p>Description: China power lead for the K300 Base Station</p>	<ul style="list-style-type: none">• 2m Cable
Image / Diagram	
	

Product	Technical Data
<p>Mains Cable 2.0m IEC Aus/Nz - EPT053520</p> <p>Description: Aus/Nz power lead for the K300 Base Station</p>	<ul style="list-style-type: none">• 2m Cable

Image / Diagram



Product	Technical Data
<p>Mains Cable 2.0m IEC No Plug - 78055</p> <p>Description: Open ended power lead for the K300 Base Station.</p>	<ul style="list-style-type: none"> • 2m Cable
Image / Diagram	
 <p>The image shows a black, flexible power cable coiled in a loose circle. At the right end of the coil, the cable extends to a black IEC connector. The connector has three rectangular slots for the prongs of a standard IEC power plug. The background is plain white.</p>	

Sensors & Encoders

- Sensors 19**
 - K300 Product Detect NPN Photoreflex Switch Assembly - EPT083423..... 19
 - K300 Product Detector Proximity Switch Assembly - EPT083424..... 20
- Encoders..... 21**
 - K300 Programmable Shaft Encoder Kit - EPT083422..... 21
 - Encoder Programmer and Cable Assembly - EPT074130..... 22
 - Flexible Arm for Encoder - EPT060492 23

Sensors

Product	Kit Components
<p>K300 Product Detect NPN Photoreflex Switch Assembly - EPT083423</p> <p>Description: Print actuator, triggered by light beam to reflective surface being broken, typically by item to be printed on.</p>	<p>1 x Photoelectric Sensor – M18, 0.03m, - 7.2m, NPN, Plastic Housing 1 x Connector D-Sub DB9 Female 1 x Cable, M12 4 Pin Female Straight, 5m PVC to Flying Leads, Shielded</p>
Image / Diagram	
	

Product	Kit Components
<p>K300 Product Detector Proximity Switch Assembly - EPT083424</p> <p>Description: Print actuator, triggered by distance from sensor being activated, typically by item to be printed on or part of transport assembly.</p>	<p>1 x Proximity Sensor, M12 Male Connector, 4-Pin, 4mm, Flush, NPN, Brass N Pltd</p> <p>1 x Connector D-Sub D89 Female</p> <p>1 x Cable, M12 4 Pin Female Straight, 5m PVC to Flying Leads, Shield</p>

Image / Diagram



Encoders

Product	Kit Components
<p>K300 Programmable Shaft Encoder Kit - EPT083422</p> <p>Description: Encoder designed to control print speed on a variable speed production line.</p>	<p>1 x K300 Programmed Encoder, 9448PPRI x Mounting Plate Encoder 3 x Screw Socket Button Head M4 x 8 A4 1 x Encoder Wheel 200</p>

Image / Diagram



Product	Kit Components
<p>Encoder Programmer and Cable Assembly - EPT074130</p> <p>Description: Encoder designed to control print speed on a variable speed production line.</p>	<p>1 x Encoder Programmer 1 x Encoder Programmer Cable Assembly</p>

Image / Diagram



Product	Technical Data
<p data-bbox="204 286 678 369">Flexible Arm for Encoder - EPT060492</p> <p data-bbox="204 409 785 517">Description: Spring loaded encoder arm to maintain excellent contact with production line to improve printing accuracy.</p>	<ul data-bbox="874 264 1380 336" style="list-style-type: none">• Adjustable Tension• M3 & M4 Encoder Mounting Holes
Image/ Diagram	
	

K300 Spares

- K300 Spares 24**
- Base Station Spares 25
- Print Station Spares..... 29
- Conduits 33
- Generic Spares 34
- Controller 36

Base Station Spares

Image	Description	Quantity per kit
	<p>EPT083605SP K300 Base Unit Service Kit Spare</p> <p>Kit Components Filter 25mm 10µm SS Female Luer/3/16" Hose Barb Non-Sterile Filter, Disk 33mm 10µm, Inline, Luer</p>	<p>4</p> <p>2</p>
	<p>EPT065685SP K300 Base Station Reservoir Assembly Spare</p>	<p>1</p>
	<p>EPT076743SP K300 Base Unit Double Head Upgrade Kit Spare</p> <p>Kit Components K300 Base Station Reservoir Assembly Cable Assembly K300 Base Extender Float Switch Cable Assembly K300 Base Extender Fill Pump Cable Assembly K300 Base Extender Solenoid "Y" Union 4mm x 4mm x 4mm</p>	<p>1</p> <p>1</p> <p>1</p> <p>1</p> <p>1</p>
	<p>EPT08923ISP K300 Base Extender Cable Assembly Kit Spare</p>	<p>1</p>









Image	Description	Quantity per kit
	<p>EPT089233SP K300 PSU Cable Kit Spare</p> <p>Kit Components K300 Base Unit Power Inlet Cable Assembly</p> <p>K300 Base Unit PCB Power Cable Assembly</p>	<p>I</p> <p>I</p>
	<p>EPT066852SP K300 PSU Spare</p>	<p>I</p>
	<p>EPT065216SP I/O Panel with PCB Assembly Spare</p>	<p>I</p>
	<p>EPT087630SP K300 Fill Pump Spare</p>	<p>I</p>

Image	Description	Quantity per kit
	<p>EPT059311SP K300 Vacuum Pump Assembly Spare</p>	<p>1</p>
	<p>EPT096603SP K300 Vacuum Chamber</p>	<p>1</p>
	<p>EPT059352SP K300 Vanity Shield Spare</p>	<p>1</p>
	<p>EPT089240SP K300 QMM Kit Spare</p>	<p>1</p>

Image	Description	Quantity per kit
	<p>EPT075510SP K300 Ink Bottle Accessory Kit Spare</p>	<p>1</p>
	<p>EPT059326SP K300 Bottle Tube Kit Spare</p>	<p>1</p>
	<p>EPT087635SP K300 Sealing Kit (Base Unit Reservoir) Spare</p> <p>Kit Components</p> <p>O-Ring 2.9mmID x 1.78mmCS, EPDM PER, 70 ShoreA</p> <p>O-Ring 4mmID x 1.5mmCS, EPDM PER, 70 ShoreA</p> <p>Washer, Peroxide Cured EPDM, 15mmOD x 10mmID x 1mm Thick, 70ShA</p> <p>K300 Base Station Reservoir Gasket</p>	<p>1</p> <p>4</p> <p>4</p> <p>1</p> <p>1</p>
	<p>EPT083613SP K300 Mains Fuse Pack Spare (contains 5 fuses)</p>	<p>1</p>

Print Station Spares

Image	Description	Quantity per kit
	<p>EPT083606SP K300 Print Station Service Kit Spare</p> <p>Kit Components Filter 25mm 10µm SS Female Luer/3/16" Hose Barb Non-Sterile</p> <p>Filter, Disk 45mm 5µm, Inline, Jaco 6mm</p>	<p>2</p> <p>1</p>
	<p>EPT063861SP K300 Print Station Front Cover Assembly Spare</p>	<p>1</p>
	<p>EPT097007SP K300 Dual Sensor Faceplate Assembly Spare- No Print Engine or Seal Cap Spare</p>	<p>1</p>
	<p>EPT093861SP K300 Dual Sensor Faceplate Assembly Spare</p>	<p>1</p>

Image	Description	Quantity per kit
	<p>EPT084077SP K300 Gen6 Ribbon Cable Assembly Spare</p>	<p>1</p>
	<p>EPT087636SP K300 Gen6 Print Engine Spare</p>	<p>1</p>
	<p>EPT055587SP K300 Tank Assembly Spare</p>	<p>1</p>
	<p>EPT064146SP K300 Print Station Fan with Cable Assembly Spare</p>	<p>1</p>





Image	Description	Quantity per kit
	<p>EPT062540SP K300 Ink System PCB Assembly Spare</p>	1
	<p>EPT062539SP K300 Print Manager PCB Assembly Spare</p>	1
	<p>EPT062542SP K300 Personality PCB Assembly Spare</p>	1
	<p>EPT064126SP K300 Display Interface PCBA Spare</p>	1
	<p>EPT087629SP K300 Apex Assembly Spare</p>	1





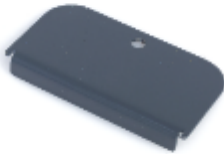

	Image	Description	Quantity per kit
		<p>EPT063854SP K300 Print Station Front PCB Assembly Spare</p>	<p>1</p>
		<p>EPT089229SP K300 Ink System and Display Cable Kit Spare</p> <p>Kit Components K300 Ink System Power Cable Assembly</p> <p>K300 Display Cable Assembly</p> <p>K300 Ink System UART Cable Assembly</p>	<p>1</p> <p>1</p> <p>1</p>
		<p>EPT087632SP K300 Thermal Fuse and Ancillary Kit Spare</p>	<p>1</p>
		<p>EPT088645SP K300 Pulse Damper Assembly Spare</p>	<p>1</p>
		<p>EPT068308SP K300 Seal Cap Assembly Spare</p>	<p>1</p>

	Image	Description	Quantity per kit
		<p>EPT095453SP K300 Nozzle Wiper Tool</p>	<p>1</p>
		<p>EPT064119SP K300 SD Card Cover Spare</p>	<p>1</p>
		<p>EPT074100SP K300 SDHC Card – 32GB (Unprogrammed) Spare</p>	<p>1</p>

Conduits

	Image	Description	Quantity per kit
		<p>K300 Braided Conduit Assembly</p> <p>EPT087448 – 1.5m EPT087447 – 2.5m EPT087362 – 4.5m</p>	<p>1</p>

Generic Spares



Image	Description	Quantity per kit
	<p>EPT087634SP K300 Sealing Kit (Print Station) Spare</p>	<p>1</p>
	<p>Kit Components O-Ring 2.57mmID x 1.78mmCS, EPDM PER, 70 ShoreA</p>	<p>5</p>
	<p>O-Ring 4mmID x 1.5mmCS, EPDM PER, 70 ShoreA</p>	<p>4</p>
	<p>O-Ring 75.92mmID x 1.78mmCS, EPDM PER, 70 ShoreA</p>	<p>1</p>
	<p>O-Ring 45mmID x 4mmCS, EPDM PER, 70 ShA</p>	<p>1</p>
	<p>Washer, Peroxide Cured EPDM, 15mmOD x 10mmID x 1mm Thick, 70ShA</p>	<p>1</p>
	<p>O-Ring 2.5mmID x 1mmCS, EPDM PER, 70 ShoreA</p>	<p>4</p>
	<p>O-Ring 3mmID x 1mmCS, EPDM PER, 70 ShoreA K300 Tank Gasket</p>	<p>4 1</p>

Image	Description	Quantity per kit
	<p>EPT089173SP K300 Screw Kit Spare</p> <p>Kit Components Screw Kit K300 Base Unit Screw Kit K300 Print Station</p>	<p>I I</p>
	<p>EPT083612SP K300 System Tube Kit Spare</p> <p>Kit Components Tube Nylon Black 6mm OD x 4mm ID Tube Nylon Black 4mm OD x 2.5mm ID Elbow, One Touch, Ø6 - G1/8, NBR Seals, Plastic Body, NI Brass Fixings Elbow, One Touch, Ø6MM - M5, NBR Seals, NI Brass Fixing Straight, One Touch, Ø6MM - M5, NBR Seals, Plastic Body, NI Brass Fixing Elbow, One Touch, Ø4MM - M5, NBR Seals, NI Brass Fixing</p>	<p>I.2m 1m 2 5 2 1</p>

Controller

	Image	Description	Quantity per kit
		<p>EPT040811 Editor Starlight Advanced</p> <p>Kit Components</p> <p>Monitor 24" DVI/HDMI/VGA</p> <p>Logitech Mouse B100</p> <p>Desktop Keyboard GB</p> <p>Purelink DVI Cable 2M</p> <p>Cardboard Box Cabinet Editor Starlight</p> <p>Manual Editor Starlight</p> <p>Editor Starlight Cabinet Advanced</p> <p>Purelink Adaptor HDMI – DVI</p> <p>Windows 10 IOT Enterprise 2019 LTSC License</p>	<p></p> <p>1</p> <p>1</p> <p>1</p> <p>1</p> <p>1</p> <p>1</p> <p>1</p> <p>1</p> <p>1</p> <p>1</p>

Image	Description	Quantity per kit
	EPT054944 Editor Starlight Data Controller	
	Kit Components Monitor 24" DVI/HDMI/VGA	1
	Logitech Mouse B100	1
	Desktop Keyboard GB	1
	Purelink DVI Cable 2M	1
	Manual Editor Starlight	1
	Purelink Adaptor HDMI – DVI	1
	Ethernet Switch 8 Port Gigabit Man. W. Power Supply 100-240V	1
	Power Supply for Advantech PC	1
	Windows 10 IOT Enterprise 2019 LTSC License	1
	PC Cube without Cards MIC-7700Q i7 – MIC-75M20 2 Slots	1
	Bracket PC-Base Editor Starlight	1
	RJ45 Patch Cable 2m CAT 6/EA S/FTP Green	1
	Spiral hose 10-100mm Black SBPE9-PE-BK-30M	1.5M

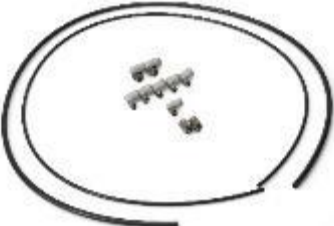
Image	Description	Quantity per kit
	<p>EPT097633 QSK (QuickStep-K) Installer Software</p>	<p>1</p>
	<p>EPT057431 Domino Designer Distribution Image</p>	<p>1</p>
	<p>EPT085757 Editor Starlight K300 License</p>	<p>1</p>
	<p>EPT091940 K300 Editor Starlight Cable Kit</p> <p>Kit Components</p> <p>K300 Encoder to Editor Input Cable Assembly</p> <p>K300 Editor Starlight Trigger Cable Assembly</p> <p>K300 Editor Starlight Encoder Cable Assembly</p>	<p>1</p> <p>1</p> <p>1</p> <p>1</p>

DCI Type2

Domino Cloud Interface

Various connection options are available (Cellular, Wi-Fi, etc.) used with country specific options. Therefore, please contact your local Domino representative for more details.

Image	Description	Quantity per kit
	<p>EPT066542 EPT066544 EPT066545 EPT095840 EPT066547</p> <p>Domino Cloud Interface (DCI) Type 2 with Cellular connectivity.</p>	1
	<p>EPT066546</p> <p>Domino Cloud Interface (DCI) Type 2 without Cellular connectivity.</p>	1
	<p>EPT068759</p> <p>Domino Cloud Interface (DCI) Type 2 Wi-Fi</p>	1
	<p>EPT064548</p> <p>DCI Wall Mount Power Supply</p>	1
	<p>EPT064047</p> <p>Ethernet Cable, 5m</p>	1

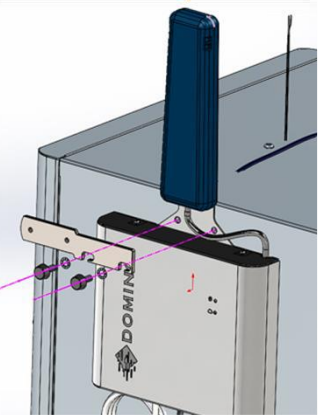
Image	Description	Quantity per kit
	<p>EPT079583 DCI Type2 Beacon Attachment</p>	<p>1</p>

Documentation

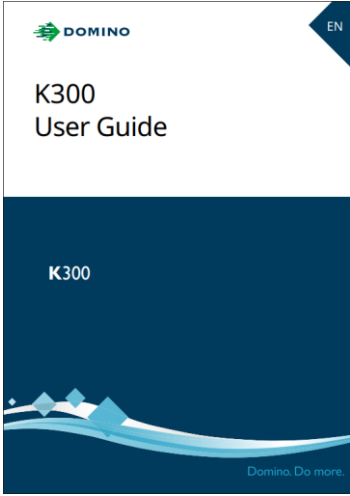
Image	Description	Quantity per kit
	<p>K300 User Guide</p> <p>English – EPT072133 Arabic – EPT097891 Chinese Simplified – EPT097893 Chinese Traditional – EPT097894 Dutch – EPT088359 English – EPT072133 French – EPT084726 German – EPT088358 Indonesian – EPT097892 Italian – EPT097896 Japanese – EPT098163 Korean – EPT088357 Malay – EPT097897 Polish – EPT097895 Portuguese – EPT084728 Spanish – EPT084727 Swedish – EPT091067 Thai – EPT084729 Vietnamese – EPT097898</p>	<p>1</p>

Notes



Domino K300 Spares & Accessories Catalogue

Domino Printing Sciences plc has a policy of continuous product improvement, the Company therefore reserves the right to modify the specification contained within this document without notice.

© Domino Printing Sciences plc 2025. All rights reserved.



For additional documentation, including other available languages, either scan the QR code, or go to <https://mydomino.domino-printing.com>

Domino UK Limited
Trafalgar Way
Bar Hill
Cambridge CB23 8TU
United Kingdom
Tel: +44 (0)1954 782551
Fax: +44 (0)1954 782874
Email: enquiries@domino-uk.com

Domino Amjet Inc.
1290 Lakeside Drive
Gurnee IL.60031
U.S.A.
Tel: +1 847 244 2501
Fax: +1 847 244 1421
Email: solutions@domino-na.com

EPT090960