



K600i digital foiling



A unique solution for brand protection,
authenticity and product embellishment



Domino. Do more.

Digital cold foiling

This innovative digital solution from Domino enables conventional metallic foils to be digitally applied to label and packaging substrates including features such as variable text, security marks and graphics.

This unique process combines the benefits of variable content digital printing with metallic foils typically used in the analogue 'cold foiling' process. This combination provides an enhanced security feature representing a unique added value capability for your customers.

At speeds up to 75m/min, the Domino **K600i** cold foiling system delivers real productivity. Combine this with virtually no make ready, no printing plates or dies, along with low maintenance and you have a highly efficient system to help you increase sales and profitability.

Domino brings the cold foiling process into the digital age!

Applications

Security

Digital cold foiling is used to enhance brand protection, provide traceability and represents an enhanced anti-counterfeiting measure. By combining the 'printing' of variable content onto customer specific customised holographic foils, it provides increased complexity and a heightened level of security, that is difficult to replicate.



Decorative embellishment

Especially for short run work, digital cold foiling is highly efficient method to apply decorative foils to pharmaceutical, personal care, cosmetics & food beverage labels and packaging.



The process

The digital foiling process

The Domino **K600i** digital printer lays down the image/pattern for the foil on the substrate using a UV curable adhesive.

The foil is laminated onto the substrate and passed under a UV lamp, curing the foil to the substrate.

Foil that does not have any adhesive under it is delaminated from the media, revealing the desired foiled image/pattern cured on the substrate.

Flexibility and choice

Curing the adhesive using UV technology allows a wide range of foils to be applied to a range of substrates.

This solution also offers the flexibility to run multiple foil types/jobs across the web width simultaneously.

Scalable modular solution

The **K600i** is a modular and scalable solution offering variable digital cold-foiling from 108mm (4.25") up to 782mm (30.81") wide.

Using the Domino **i-Tech StitchLink** technology, seamless images can be applied across the full web width.

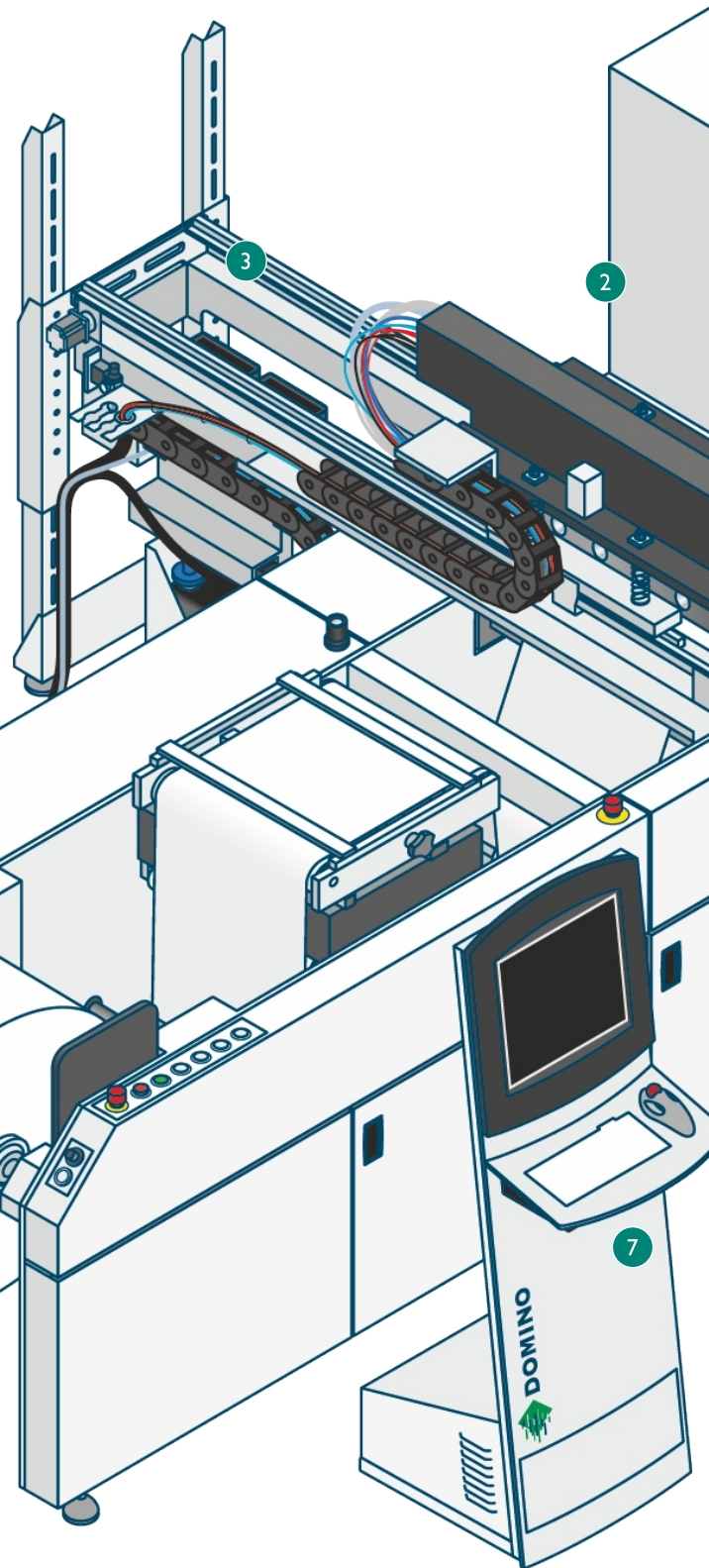

Easy to integrate

The Domino **K600i**'s compact and modular platform can be integrated onto a web-fed press or finishing line, or it can be supplied as a standalone roll-to-roll solution.

In the example illustrated, the **K600i** is shown integrated with an ABG web system, configured with unwinder, dedicated base for the **K600i**, foil lamination module, UV curing, inspection and rewinder.

Accurate and reliable web control is required to achieve the highest quality results.

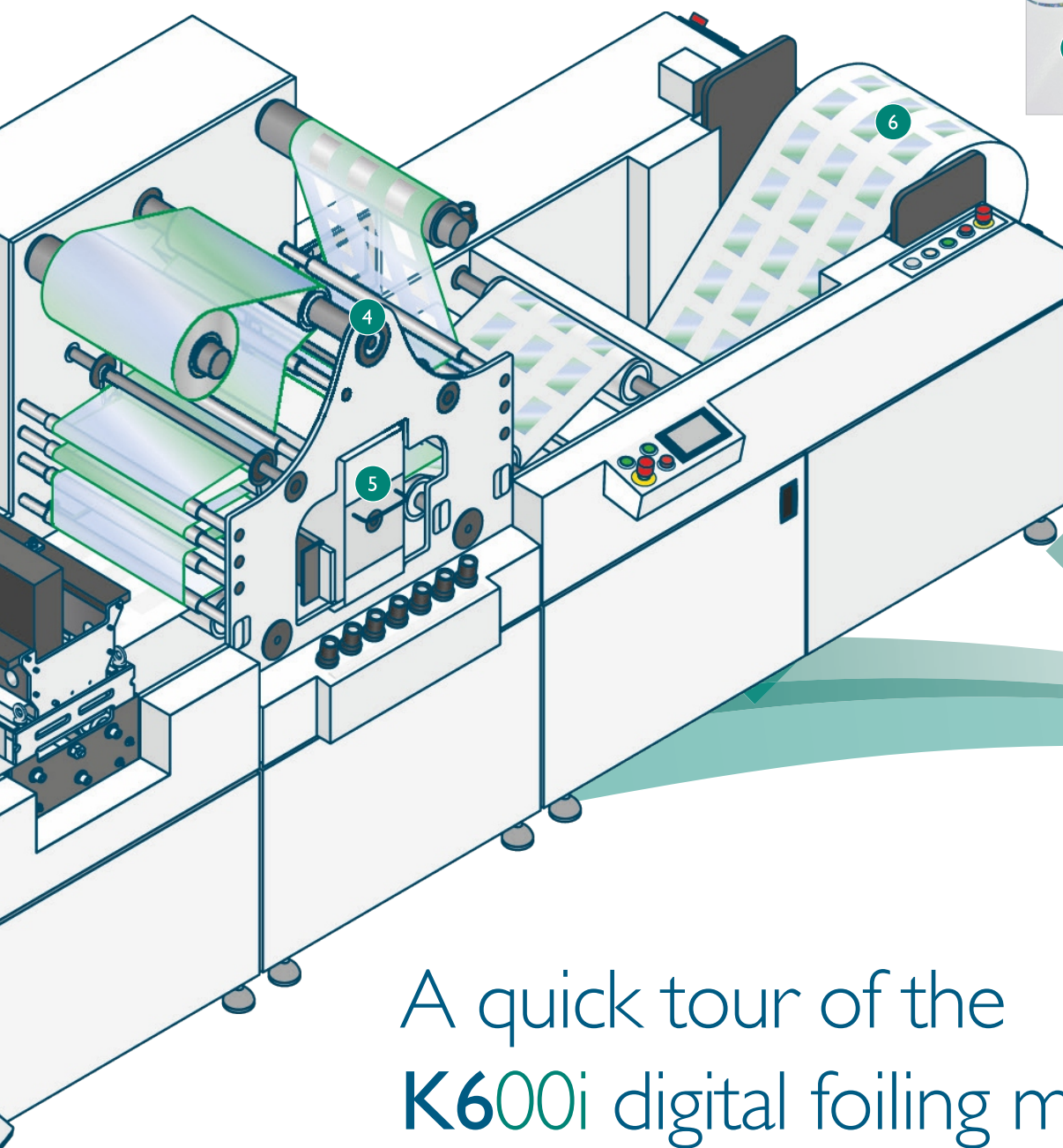

A quick tour of the **K600i** digital foiling module

Key to illustration

1. Media Unwinder
2. Domino **K600i** printer
3. **i-Tech** automated **CleanCap** cleaning and capping station
4. Digital Foiling Module
5. UV Curing System
6. Digital foiled output on rewriter
7. Editor GT Industry Standard Controller
8. Holographic digital foil example

Domino. Do more.

Why use digital foiling

Advantages of digital foiling

Foils are extensively used within the premium goods sectors, and for these high value goods compared to printed foil styled inks, foils have a number of advantages:

- Brighter and more reflective
- Higher opacity, density and uniformity of colour
- Shade consistency, independent of print process
- Highly resistant to handling and abrasion
- No need to overcoat, laminate or varnish
- Flexible across large solid areas and extremely fine detail
- Extensive range of shades, holographs and finishes
- Combined with customised holograms provide unique security solutions

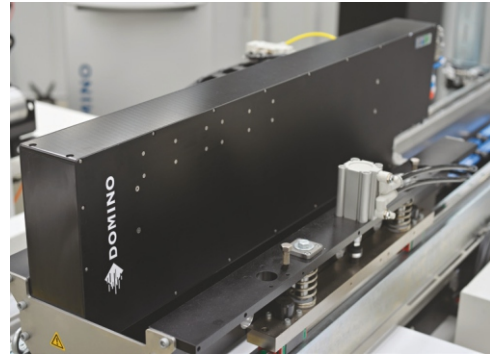

Domino. Do more.



Technical Specification:

Operational Capability

Maximum line speed	37.5 – 75m/min
Image width	108mm (4.25") to 782mm (30.81")
Nominal media to print head distance	1.0mm (0.04")
Media	Coated paper and films

Adhesive System

Adhesive Supply	10 litres (ink dependent)
Adhesive Type	UV Curable

Foil Types and Substrates

Suitable Substrates	Papers: Gloss, coated, semi-coated and some uncoated (no rough or highly absorbent substrates) Synthetics: PE, PP and PET
Foil Types	Wide range of decorative colours in flat, gloss and matt shades. Holographic stock 'wallpaper' patterns and high security customised patterns, originated upon request including registered designs.

Print Capability

Text	Fixed text, variable text
Graphics	.bmp, .pcx, .tif, .jpg, .gif, .pdf
Other Interfaces	Please contact us for more details

Key Dimensions

Conduit length - main enclosure to print head	4m (13')
Conduit length - main enclosure to flush bottle	4m (13')
333m (13') head print bar	1330w x 354.4d x 705.4h mm (height dimension excludes conduit)
10L ink supply box 108 (4.25") - 558mm (21.96")	640w x 440.4d x 425h mm (dimensions excluding conduit radius)
Flush holder	234w x 234d x 360h mm (dimensions excluding air regulator and conduit radius)

Services

Electrical	K600i	110-240v AC50-60Hz 10A (auto ranging)
Compressed Air	UV System	Operation dependent, normally 380-420v three phase drop 6-8 bar clean dry supply

Environment

Optimum temperature range	20-30°C (68-86°F)
Optimum humidity range	40-60%

Ancillary Equipment

Print head guarding, UV dryer, Web cleaner, Web guide, Anti-static bars, Reel to reel system, Arched roller section, Corona treatment.

10 litre ink supply box

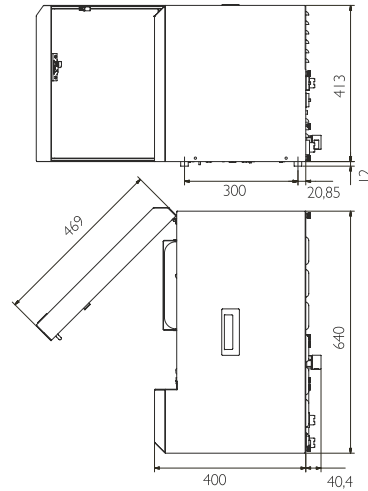

Flush holder

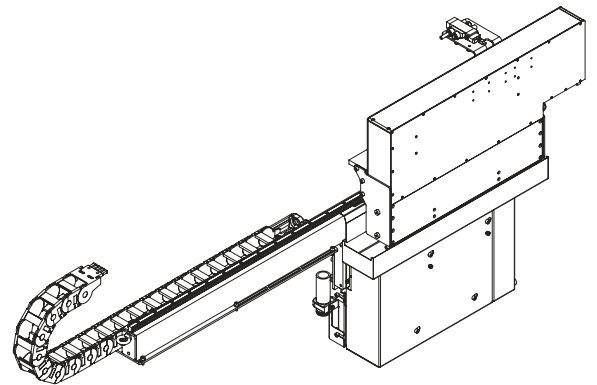
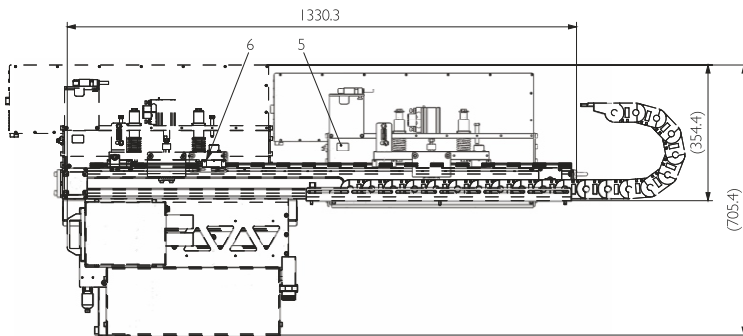
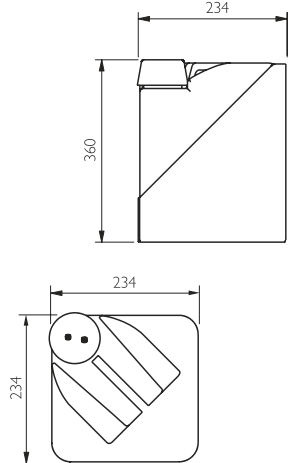

CONTACT US

TALK TO AN EXPERT

+91-900 900 6612
 enquiry@dominoindia.com
 www.domino-printing.com



KNOW MORE